



Application type	Thermal, acoustic, fire
Construction type	Walls, Rafters and floors, timber or metal frames

# Rockwool Flexi

Patented flexi-edged slab for framed constructions

A part of the Rockwool SoundPro range, Rockwool 'Flexi' is a unique insulation product with a patented flexible edge along one side. This unique Flexi edge is produced using patented technology to ensure a perfect fit is maintained between the product and its supporting framework. This ensures the insulation's integrity. Flexi is designed for a host of applications where perfect fitting insulation is essential, in walls, partitions, floors and roofs. The 'Flexi' edge allows the product to be tightly fitted between timber and metal frames, without the need for cutting or waste.

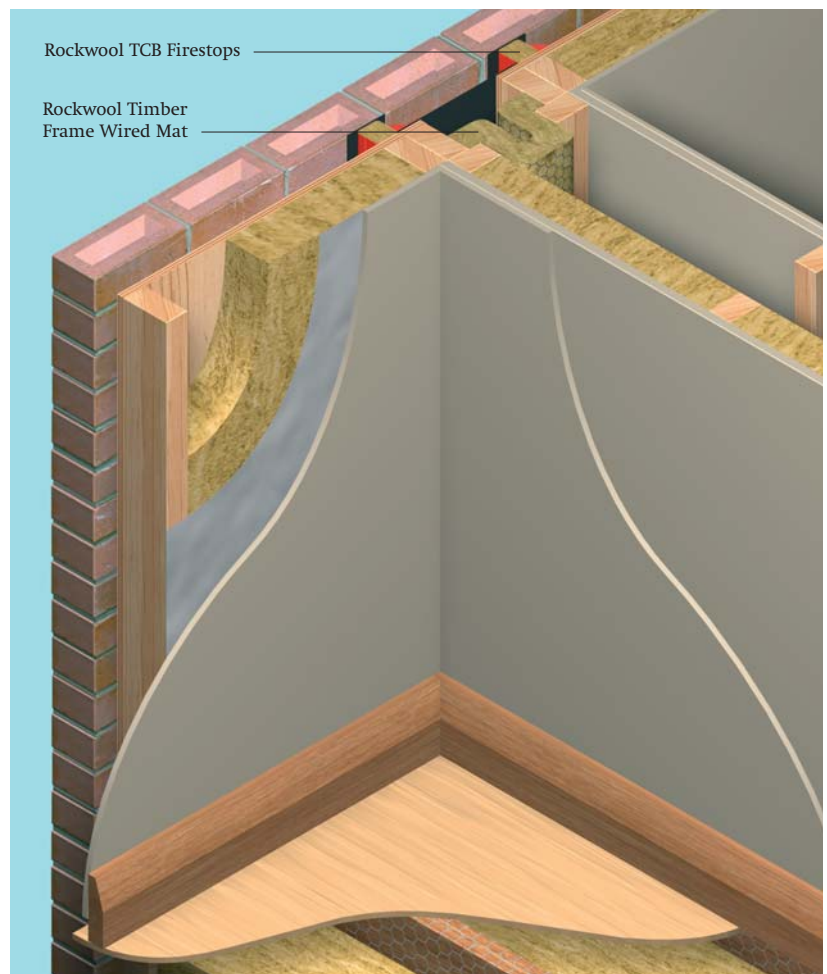

Diagram showing typical application for Rockwool Flexi and other Rockwool Firestop products

### Advantages

- patented 'Flexi' edge offers accurate fit to all widths
- will not slump if studs shrink
- multi-application, fits all typical metal and timber frame spacing
- no waste
- excellent thermal, acoustic and fire properties
- easy to handle and install without gaps

# Description, performance and properties

Rockwool Flexi is a unique semi-rigid slab with a flexible edge along one side.

The Flexi product is now available 1200 mm long × 600 mm wide and 1200 mm long × 400 mm wide, to suit standard stud and floor joist spacings.

## Product Dimensions

Length × Width	Standard available thickness (mm)
1200 mm × 600 mm	50, 60, 70, 90, 100, 120 & 140
1200 mm × 400 mm	50, 60, 100, 120 & 140

## Importance of fit

Ensuring a perfect insulation fit is essential to maintain the thermal integrity of the wall. Typical softwood timber moisture contents can range between 6% and 30%, dependant on exposure to the elements. As a rule of thumb, timber will expand 1% for every 4% of moisture content. A 100 × 47 mm timber stud can therefore expand 3 × 2 mm (each side) and then shrink back. If insulation is installed when timber has high moisture content, it can result in a potential 6 mm vertical void on each side. When the timber dries out, Rockwool Flexi will expand into this void, ensuring thermal integrity, whilst rigid insulations may leave a 6 mm gap, or even fall out.

The flexible long edge of the slab allows for the 600 mm wide product to be flexed into the 590 mm space between metal studs or into the 562 mm space between 38 mm width timber studs (see figs. 1 & 2).

Where studs are spaced at 400 mm centres, 1200 mm × 400 mm wide Rockwool Flexi should be used. The new 400 mm Rockwool Flexi option is also the ideal product to meet the new Part E acoustic requirements for internal timber or metal floor joists spaced at 400 mm centres (see page 6). Unlike roll products, Rockwool Flexi is faster and easier to friction fit between the joists from below, prior to fixing the plasterboard ceiling.

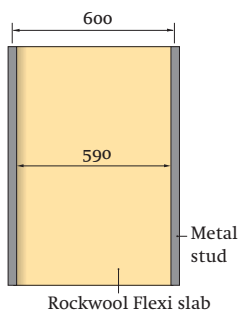

Figure 1

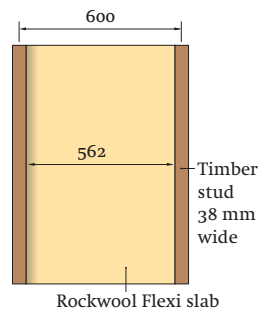

Figure 2

If 38 mm thick studs are used, 562 mm space remains.

If 50 mm thick studs are used, 550 mm space remains.

Note: if stud is not plumb, for example, 560 mm space at base and 590 mm space at top, Flexi will fit space accurately without cutting.

## Performance & properties

### Fire Classification

Rockwool Flexi achieves a reaction to Fire classification of A1, as defined in EN13501-1.

### Thermal Performance

Rockwool Flexi has a thermal conductivity of 0.038 W/mK when tested to EN13162.

At 140 mm thickness, Rockwool Flexi has a thermal conductivity of 0.035W/mK.

### Work on site

#### Handling and storage

Rockwool Flexi Slabs are light and easy to cut to any shape with a sharp knife. They are shrink wrapped in polyethylene for short term protection. For long term protection they should be stored indoors or under a waterproof covering.

### Maintenance

Once installed Rockwool Flexi needs no maintenance.

## Metal studs



Push-in 'Flexi' edge...



...and let go for perfect fit

## Timber studs



Push-in 'Flexi' edge...



...and let go for perfect fit

1 hr timber fire floor (see paragraph 3, page 8)  
100 mm flexi on chickenwire



Rockwool Flexi is designed to provide the perfect friction fit between both timber and metal framed systems. Its unique flexible edge allows the product to be pushed into the space from one side and then simply let go, springing back to fill the gap.

Unlike rigid insulants, if the timber stud contracts as a result of moisture content, Rockwool Flexi will expand to fill the void, not drop out or leave vertical gaps.

## Thermal applications – Walls

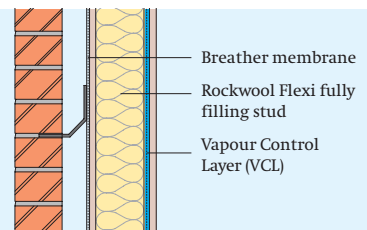

### Construction 1: Cold frame

Timber frame cavity wall, standard construction, insulation fully filling studs.

Internal finishes: (a) 1 layer plasterboard  
(b) 2 layers plasterboard

Internal finish	Standard Breather Membrane		Tyvek Reflex Breather Membrane	
	a	b	a	b
RW Flexi Thickness (mm)	U values (W/m <sup>2</sup> K)		U values (W/m <sup>2</sup> K)	
90	0.41	0.40	0.36	0.35
100	0.38	0.37	0.33	0.33
120	0.33	0.32	0.29	0.29
140	0.28	0.27	0.25	0.25

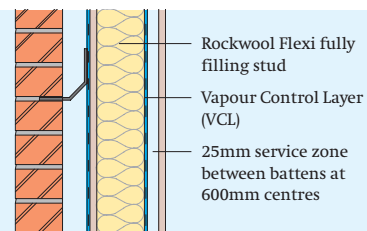

### Construction 2: Cold frame with service zone

Timber frame cavity wall with separate 25mm battened service void, insulation fully filling studs.

Internal finishes: (a) 1 layer plasterboard  
(b) 2 layers plasterboard

Internal finish	Standard Breather Membrane		Tyvek Reflex Breather Membrane	
	a	b	a	b
RW Flexi Thickness (mm)	U values (W/m <sup>2</sup> K)		U values (W/m <sup>2</sup> K)	
90	0.38	0.38	0.33	0.33
100	0.36	0.35	0.31	0.31
120	0.31	0.30	0.28	0.27
140	0.27	0.26	0.24	0.24

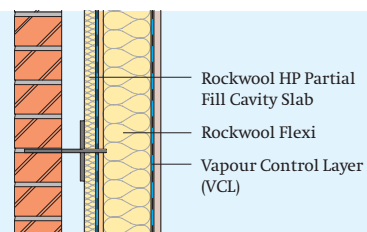

### Construction 3: Hybrid frame

Warm/hybrid timber frame cavity wall with Rockwool Flexi insulation fully filling studs and 40mm Rockwool HP Partial Fill fixed to face of sheathing.

Internal finishes: (a) 1 layer plasterboard  
(b) 2 layers plasterboard

Internal finish	40mm	
	a	b
RW Flexi Thickness (mm)	U values (W/m <sup>2</sup> K)	
90	0.28	0.27
100	0.26	0.26
120	0.24	0.23
140	0.21	0.21

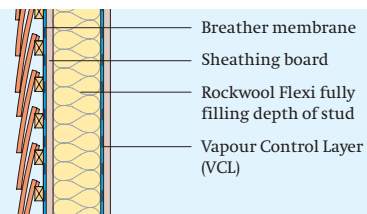

### Construction 4: Tile hanging (Cold frame)

Timber frame wall with tile hanging, Rockwool Flexi between studs only.

RW Flexi Thickness (mm)	U values (W/m <sup>2</sup> K)
120	0.35
140	0.30
180	0.25

All calculations above allow for 15% timber bridging of main frame.

## Floors

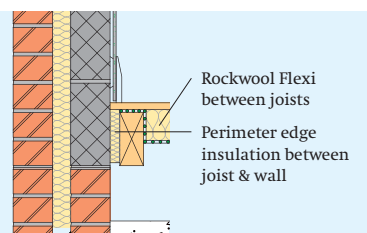

### Suspended timber floor

Rockwool Flexi is installed between joists, supported by polypropylene netting. The insulation should be fitted as close as practical to the underside of floor deck to avoid any air gaps.

Product	Flexi			
	0.25 W/m <sup>2</sup> K	0.22 W/m <sup>2</sup> K	0.20 W/m <sup>2</sup> K	0.18 W/m <sup>2</sup> K
P/A ratio	Thickness (mm)	Thickness (mm)	Thickness (mm)	Thickness (mm)
0.1	nil	nil	nil	70
0.2	70	90	120	140
0.3	90	120	140	160
0.4	120	140	150	180
0.5	120	140	160	200
0.6	120	140	180	200
0.7	120	140	180	200
0.8	140	140	180	200
0.9	140	140	180	200
1.0	140	140	180	200

## Rafters

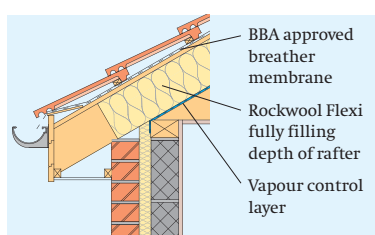

### Insulation between rafters only (Extension/Refurbishment)

Tiles/slates on 25mm counter battens on BBA approved roof breather membrane, Rockwool Flexi fitted between rafters. An airtight vapour control membrane is stapled to the underside of the rafters, with joints lapped and sealed. Ceiling finished internally with 12.5mm plasterboard.

Rafter width	38 x 100 mm		47 x 100 mm	
Joist spacing	400 mm	600 mm	400 mm	600 mm
Timber bridging	9.5%	6.3%	11.7%	7.8%
RW Flexi Thickness (mm)	U values (W/m <sup>2</sup> K)		U values (W/m <sup>2</sup> K)	
200 (100+100)	0.22	0.21	0.23	0.22
220 (100+120)	0.21	0.20	0.21	0.20
240 (100+140)	0.19	0.18	0.20	0.19

# Acoustic applications – Walls

## Acoustics

Rockwool Flexi works in two distinct ways to reduce noise, either by impeding the transmission of sound through an element of the structure, or by absorption of sound at the surface.

Noise absorption is expressed as a factor between 0 and 1.0. The more sound that a surface absorbs, the higher its absorption coefficient.

The structure of the fibres in Rockwool Flexi slabs make them ideal for use as a sound absorber, with characteristically high coefficients over a wide frequency range (see table opposite).

## Absorption coefficients for Rockwool Flexi

Thickness (mm)	Mounting	Frequency (Hz)					
		125	250	500	1K	2K	4K
50	Direct	0.15	0.60	0.90	0.90	0.90	0.85
100	Direct	0.35	0.95	1.00	0.92	0.90	0.85

The absorption coefficients shown above are typical figures that can be achieved by Rockwool Flexi. They have been obtained from a comprehensive range of measurements.  
**Note: Differences in coefficients of less than 0.15 are not significant.**

## Robust Details – Walls

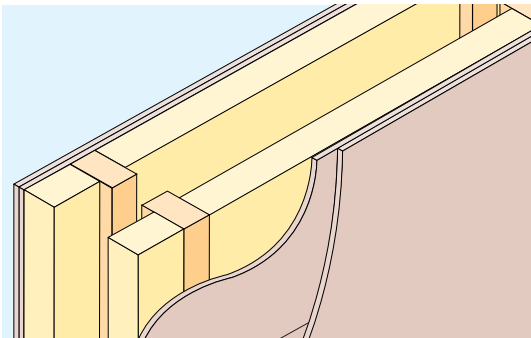

### Robust Details reference – E-WT-1 Separating wall – Timber frame

Without sheathing board  
 Twin timber frames

#### Rockwool SoundPro robust detail guidance specification

Wall width	240 mm min. between inner faces of wall linings. 50 mm min. gap between studs.
Wall lining	2 or more layers of gypsum-based board (total nominal mass per unit area 22 Kg/m <sup>2</sup> ) both sides.
Rockwool Flexi	60 mm min. both sides

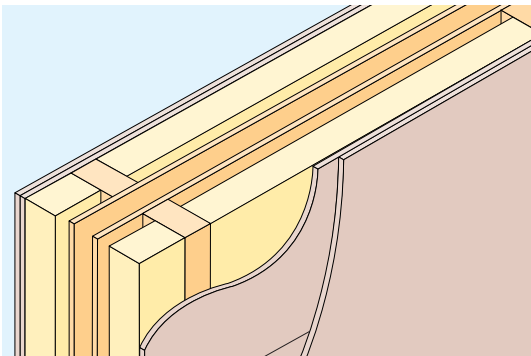

### Robust Details reference – E-WT-2 Separating wall – Timber frame

With sheathing board  
 Twin timber frames

#### Rockwool SoundPro robust detail guidance specification

Wall width	240 mm min. between inner faces of wall linings. 50 mm min. gap between studs.
Wall lining	2 or more layers of gypsum-based board (total nominal mass per unit area 22 Kg/m <sup>2</sup> ) both sides.
Sheathing	9 mm min. thick board
Rockwool Flexi	60 mm min. both sides

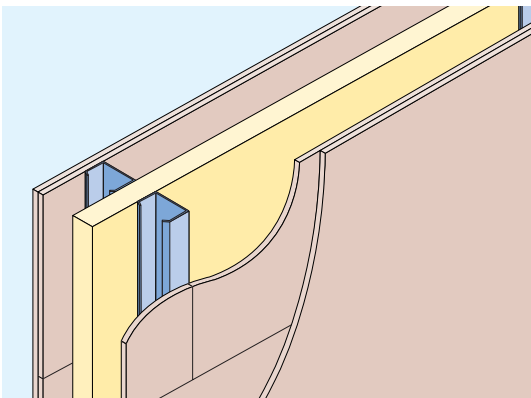

### Robust Details reference – E-WS-1 Separating wall – steel frame

Twin metal frames for use in lightweight steel frame houses and flats/apartments

#### Rockwool SoundPro robust detail guidance specification

Wall width	200 mm min. between inner faces of wall linings.
Wall lining	2 or more layers of gypsum-based board (total nominal mass per unit area 22 Kg/m <sup>2</sup> ) both sides.
Rockwool Flexi	50 mm min.

Note: The steel frame profiles shown are indicative only. Other profiles are acceptable.  
 This robust detail is only suitable for use in lightweight steel frame houses and flats/apartments.

## ADE Section 2 – Separating Walls

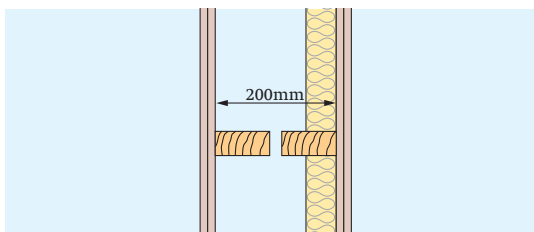

### ADE Construction guidance specifications for New build Separating Timber wall type 4

- Independent timber frames
- Min. 2 layers of plasterboard each side laid staggered joint, min mass per unit area of each board 10 Kg/m<sup>2</sup>
- Min. distance between inside faces of plasterboard linings 200 mm
- 50 mm Rockwool Flexi fitted in one frame
- Pre-completion site testing is required

# Acoustic applications – Partitions

## Acoustics

Rockwool Flexi will provide both acoustic and fire benefits when used in partitions.

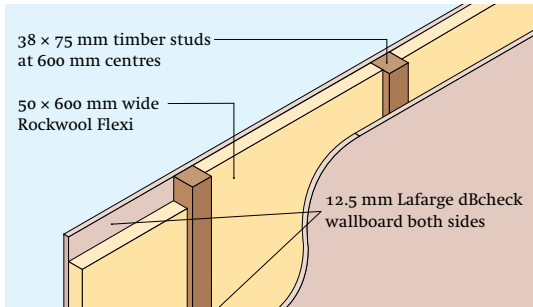

### Lightweight domestic timber stud partition

NBS Plus Clause P10:230

Studs: 38 x 75 timber studs @ 600 mm centres  
 Facings: 1 layer 12.5 mm Lafarge dBcheck wallboard (11 Kg/m<sup>2</sup>) each side  
 Insulation: 50 mm wide Rockwool Flexi

Weighted sound reduction (Rw dB) .....	40
Fire resistance (minutes) .....	30
Max height (metres) .....	3.0
Nominal thickness (mm) .....	100

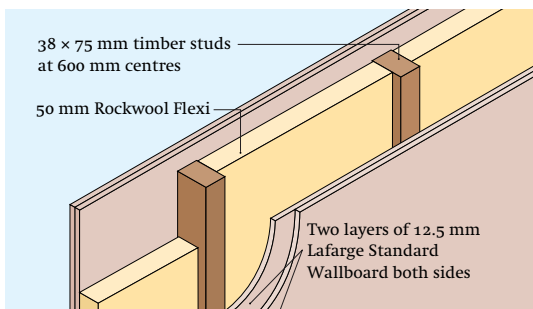

### Typical office partition adjacent to factory

NBS Plus Clause P10:230

Studs: 38 x 75 timber studs @ 600 mm centres  
 Facings: 2 layers 12.5 mm Lafarge dBcheck wallboard (8 Kg/m<sup>2</sup>) each side  
 Insulation: 50 mm wide Rockwool Flexi

Weighted sound reduction (Rw dB) .....	46
Fire resistance (minutes) .....	60
Max height (metres) .....	3.0
Nominal thickness (mm) .....	125

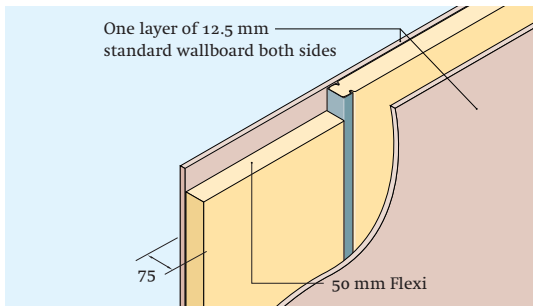

### Lightweight domestic metal stud

NBS Plus Clause K10:115, K10:125

Studs: 50 mm metal studs @ 600 mm centres  
 Facings: 1 layer 12.5 mm standard wallboard (8 Kg/m<sup>2</sup>) each side  
 Insulation: 50 mm wide Rockwool Flexi

Weighted sound reduction (Rw dB) .....	41
Fire resistance (minutes) .....	30
Max height (metres) .....	2.5
Nominal thickness (mm) .....	75

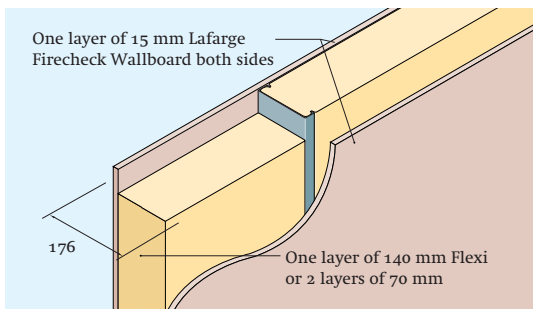

### Enhanced performance: Schools, offices and public buildings

NBS Plus Clause K10:115, K10:125

Studs: 146 mm metal studs @ 600 mm centres  
 Facings: 1 layer 15.0 mm Lafarge Firecheck wallboard (12 Kg/m<sup>2</sup>) each side  
 Insulation: 2 x 70 or 1 x 140 mm wide Rockwool Flexi

Weighted sound reduction (Rw dB) .....	53
Fire resistance (minutes) .....	60
Max height (metres) .....	6.5
Nominal thickness (mm) .....	176

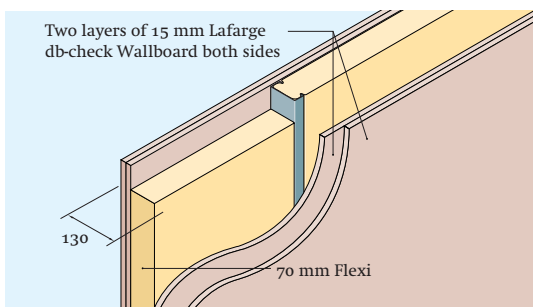

### Enhanced performance: Schools, offices and public buildings

NBS Plus Clause K10:115, K10:125

Studs: 70 mm metal studs @ 600 mm centres  
 Facings: 2 layers 15.0 mm Lafarge dBcheck wallboard (26 Kg/m<sup>2</sup>) each side  
 Insulation: 70 mm wide Rockwool Flexi

Weighted sound reduction (Rw dB) .....	57
Fire resistance (minutes) .....	90
Max height (metres) .....	4.6
Nominal thickness (mm) .....	130

## Acoustic applications – Separating floors (New build) ADE Section 3

- Points to note:**
- The floating platform floor should be isolated from the perimeter walls
  - Do not bridge between the floating layer and the base floor with services and fixings that penetrate the resilient layer
  - Leave min. 5 mm gap between the floating layer and skirtings. Seal gap with Rockwool Acoustic Sealant
  - Ensure all ceiling perimeters are sealed with tape or Rockwool Acoustic Sealant

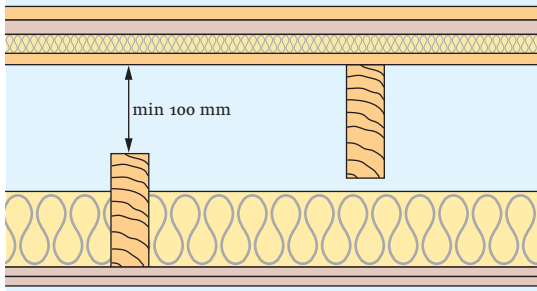

### ADE Construction guidance specifications for New build

NBS Plus Clause K11:215, 225, 235 & 245

#### Separating Timber floor type 3.1A: Timber based Platform floor with independent ceiling treatment.

- 18 mm t&g flooring grade chipboard spot bonded to
- 19 mm plasterboard plank on
- **Minimum 25 mm Rockwool Rockfloor resilient layer on**
- 15 mm OSB floor deck on timber joists.
- **Independent joisted ceiling with 100 mm Rockwool Flexi.**
- Ceiling finish, comprising of 2 layers of plasterboard, min mass per unit area 20 Kg/m<sup>2</sup> (Eg 2 layers of 12.5 mm Lafarge dBcheck has overall mass of 22 Kg/m<sup>2</sup>)
- Pre-completion site testing is required

### ADE Construction guidance specifications for New build

NBS Plus Clause M10:290, M13:260

#### Separating Pre-cast Concrete floor type 2

- 65 mm (min) sand cement screed or
- alternative 40 mm (min) proprietary screed
- Separating layer
- **25 mm Rockwool Rockfloor resilient layer on**
- Pre-cast concrete plank floor with all joints fully grouted (min mass per unit area 300 Kg/m<sup>2</sup>)
- Ceiling treatment: single layer plasterboard (min mass 10 Kg/m<sup>2</sup>) fixed to resilient bars which are fixed to timber battens
- **50 mm Rockwool Flexi between battens**
- Pre-completion site testing is required

## Alternative Rockwool systems for ADE compliance

The following Rockwool solutions have the potential to meet the requirements set out in Part E Section 3 and to provide a minimum fire resistance of 60 mins.

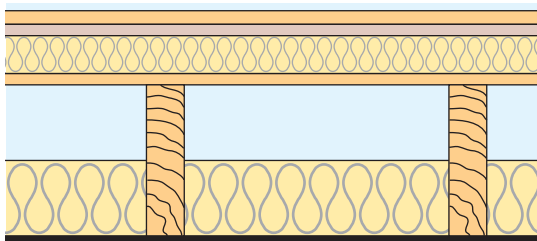

For details of this acoustic solution with downlights, refer to SoundPro brochure, Section E1 (New build), page 3, solution 6

### Timber platform floor

NBS Plus Clause K11:215, 225, 235 & 245

Airborne: Rw 54 dB (Rw 66 - 12 Ctr) Impact: Lnw 54 dB Test Report ref. L03 272 & 273

#### Rockwool floor type 3.1A guidance specification

- 18 mm t&g flooring grade chipboard on
- 15 mm Lafarge dBcheck wallboard on
- **50 mm Rockwool Rockfloor resilient layer on**
- 15 mm OSB on
- 200 × 50 mm timber joists @ 400 mm ctrs
- **100 mm Rockwool Flexi between joists**
- Resilient bars fixed at right angles to joists @ 400 mm ctrs.
- Ceiling finish, 2 layers of 15 mm Lafarge dBcheck wallboard (26 Kg/m<sup>2</sup>)
- Pre-completion site testing is required

### Timber batten raft floor

NBS Plus Clause K20:150 & 160

Airborne: Rw 49 dB (Rw 62 - 13 Ctr) Impact: Lnw 55 dB Test Report ref. BTC 12402A

#### Rockwool floor type 3.1A guidance specification

- 18 mm t&g flooring grade chipboard on
- 15 mm Lafarge dBcheck wallboard screw fixed to
- 45 × 45 mm softwood battens @ 400 mm ctrs. with
- 6 mm Lafarge RAFT60 foam rubber tape bonded to underside laid on
- 15 mm OSB with
- **50 mm Rockwool Flexi between battens laid on**
- 195 × 45 mm timber joists @ 400 mm ctrs
- **100 mm Rockwool Flexi between joists**
- Resilient bars fixed at right angles to joists @ 400 mm ctrs.
- Ceiling finish, 2 layers of 15 mm Lafarge dBcheck wallboard (26 Kg/m<sup>2</sup>)
- Pre-completion site testing is required

## Internal floors

### Rockwool system for ADE compliance to ADE Section 5 – Internal floors

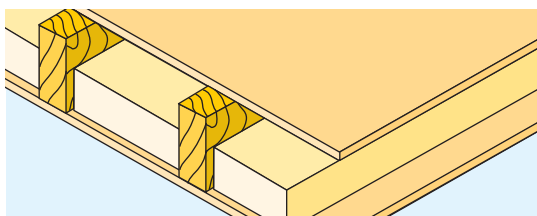

### Timber joist Internal Floor (Domestic internal floor)

#### To meet part E2

NBS Plus Clause P10:240

Rw 40 dB Test Report ref. L03 264 & 265

#### Rockwool guidance specification

- Standard 18 mm t&g flooring grade chipboard, mass per unit area 12.4 Kg/m<sup>2</sup>
- Timber joists @ 400 mm ctrs.
- **100 mm thick Rockwool Flexi between joists**
- Single layer of Standard 12.5 mm plasterboard ceiling, mass per unit area 8 Kg/m<sup>2</sup>

## Acoustic applications – Separating floors (Material change of use) ADE Section 4

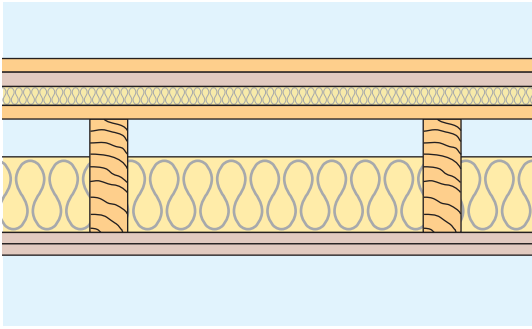

### ADE Construction guidance specifications for Material change of use Separating Timber floor treatment 2: Platform floor with absorbent material NBS Plus Clause K11:215, 225, 235 & 245

- Min 2 layers of board material to provide min total mass 25 Kg/m<sup>2</sup> spot bonded together with joints staggered (eg 18 mm t&g flooring grade chipboard & 19 mm plasterboard plank).
- 25 mm (min) Rockwool Rockfloor resilient layer laid on
- The floating layer to be loose laid over the Rockfloor
- Existing floor deck on existing timber floor joists
- 100 mm Rockwool Flexi
- Existing ceiling upgraded to 20 Kg/m<sup>2</sup>. If existing ceiling is of lath & plaster it should be retained providing it satisfies Part B – Fire Safety. (If in doubt, underdraw with an additional layer of 12.5 mm Firecheck board & screw into joists)
- Pre-completion site testing is required

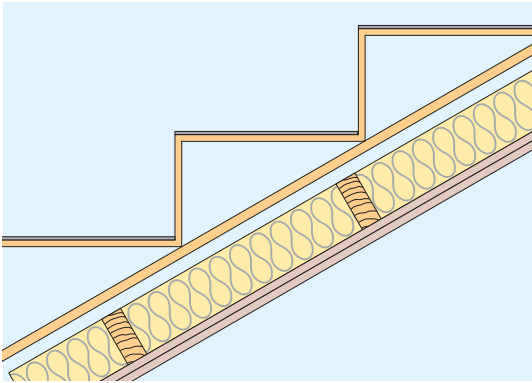

### ADE Construction guidance specifications for Material change of use: Stair treatment NBS Plus Clause P10:240

Stairs are subject to the same sound insulation requirements as floors where they form a separating function.

- Follow detail provided by diagrams 4-1 and 4-8 of ADE
- Where there is no cupboard under the stairs:  
An independent ceiling should be constructed below  
Use Rockwool Flexi slab within the construction
- Where there is a cupboard under the stairs:  
Lay soft covering min 6 mm thick over treads  
Line underside of stairs with min 1 layer of plasterboard (mass 10 Kg/m<sup>2</sup>)  
Fill space above lining with Rockwool Flexi  
Build cupboard walls using 2 layers of wallboard (each having min mass 10 Kg/m<sup>2</sup>)  
Use small heavy well fitted cupboard door
- Pre-completion site testing is required

## Alternative Rockwool system for ADE compliance

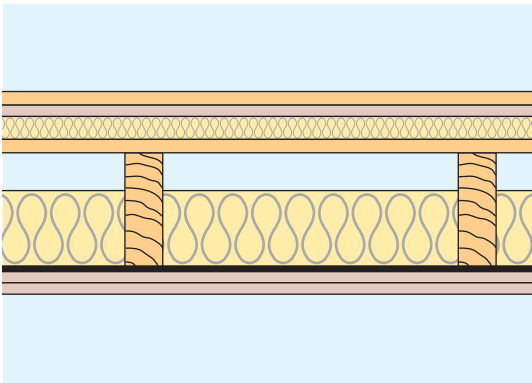

### Separating timber platform floor construction

NBS Plus Clause K11:215, 225, 235 & 245

*Airborne: Rw 48 dB (Rw 59 - 11 Ctr) Impact: Lnw 57 dB*

*Test Report ref. BTC 12397A Field test Report ref. 2271*

Enhanced solution using resilient bars

If the existing ceiling is being replaced, the sound performance of the floor can be further enhanced by fitting resilient bars which isolate the ceiling from the floor structure.

Rockwool SoundPro guidance specification

- 18 mm t&g flooring grade chipboard spot bonded to 15 mm Lafarge dBcheck board. (total mass 28 Kg/m<sup>2</sup>)
- 30 mm (min) Rockwool Rockfloor resilient layer
- Min 15 mm OSB floor deck on existing timber floor joists (min 195 mm × 45 mm)
- 100 mm Rockwool Flexi between joists
- Resilient bars fixed at right angles to joists @ 400 mm ctrs.
- Ceiling finish 2 layers of 15 mm Lafarge dBcheck board (26 Kg/m<sup>2</sup>)
- Pre-completion site testing is required

## Acoustic applications – Separating walls (Material change of use) ADE Section 4

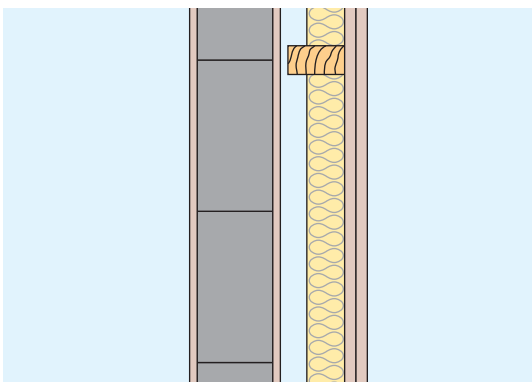

### ADE Construction guidance specifications for Wall Treatment 1: Existing solid masonry wall with independent panel(s)

NBS Plus Clause K10:145, 155, 165, 185 & 420

- 100 mm (min) existing solid masonry wall plastered on both faces
- Independent timber or steel studs. Min 10 mm gap to be maintained between frame & existing wall
- 50 mm Rockwool Flexi between studs
- 2 layers of plasterboard min 20 Kg/m<sup>2</sup> (approx = to 2 × 15 mm std wallboard or 2 × 12.5 mm E-check plasterboards)
- Avoiding flanking transmission: seal perimeter edges of new plasterboard with tape or Rockwool Acoustic Sealant
- If existing masonry wall is not plastered or less than 100 mm thick then independent panels should be applied to both sides
- Pre-completion site testing is required

## Special specification clauses

### Thermal insulation

#### 1 Flexi slab

Thermal insulation to be Rockwool Flexi 600 or 400 mm wide (delete which is not required) × .....\* (\* insert 50†, 60†, 70, 90, 100†, 120† or 140† mm thickness), width to suit stud centres of ..... (insert 400 or 600 mm), applied between studs or joists to a friction fit. All material joints shall be tightly butted.

† Available as both 400 and 600 mm width.

#### 2 Dry lining using Flexi

The thermal insulation is to be Rockwool Flexi .....\* mm thick × 600 or 400 mm wide (delete which is not required), applied between timber/metal frame. A vapour control layer is applied before fixing the plasterboard. If a plasterboard with a vapour check is used a vapour control layer may not be required. It is important that the vertical joint in the plasterboard lining should coincide with the centre line of the main frame.

### Fire protection

3 One hour fire resisting floor using Rockwool Flexi  
Remove floor boards and install a continuous run of 25 mm Ø chicken wire mesh across the whole floor. Form the mesh so that it follows the profile of the joists and the top face of the ceiling lining. 100 mm Rockwool Flexi to fit tightly between the joists and supported by the mesh. Lay new floor of either (a) 19 mm flooring grade t & g chipboard or (b) square edged softwood boards plus a layer of 3 mm hardboard above or below the boards.

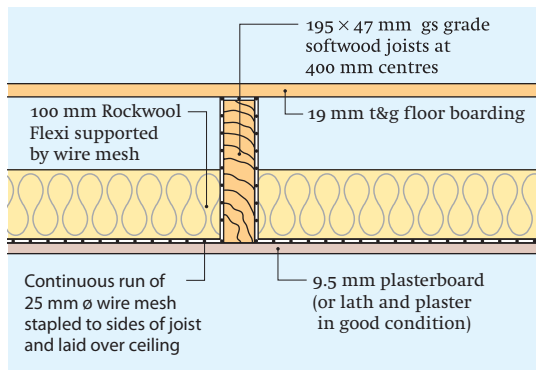

1 hour fire resistant floor based on fire test to BS476: Part 21

### Acoustic insulation

#### 4 Rockwool Flexi as acoustic infill to stud partition

The acoustic infill is to be Rockwool Flexi .....\* mm thick × 600 or 400 mm wide (delete which is not required) installed to a tight fit between the studs and cut to close fit above and below horizontal noggings as necessary.

## Ordering

### Rockwool Flexi:

Please quote thickness, width and area required.

### Rockwool Rockfloor:

Please quote thickness and area required.

### Rockwool HP Partial Fill Slabs:

Please quote thickness and area required.

### Rockwool Timber Frame Wired Mat:

Please quote number of rolls or linear metres required.

## Packaging

Rockwool Flexi is supplied compression packed in a polyethylene bag.

## Health and safety

Current HSE 'CHIP' Regulations and EU directive 97/69/EC confirm the safety of Rockwool mineral wool; Rockwool fibres are not classified as a possible human carcinogen.

The maximum exposure limit for mineral wool is 5mg/m<sup>3</sup>, 8 hour time-weighted average.

A Material Safety Data Sheet is available from the Rockwool Marketing Services Department to assist in the preparation of risk assessments, as required by the Control of Substances Hazardous to Health Regulations (COSHH).

## Environment

Rockwool insulation relies on entrapped air for its thermal properties; air is not a VOC and it does not have Global Warming Potential (GWP) or Ozone Depleting Potential (ODP).



## Technical Information

For further details visit our website at [www.rockwool.co.uk](http://www.rockwool.co.uk) or phone the Technical Hotline on 0871 222 1780

Rockwool Limited reserves the right to alter or amend the specification of products without notice as our policy is one of constant improvement.

The information contained in this data sheet is believed to be correct at the date of publication. Whilst Rockwool will endeavour to keep its publications up to date, readers will appreciate that between publications there may be pertinent changes in the law, or other developments affecting the accuracy of the information contained in this data sheet.

The above applications do not necessarily represent an exhaustive list of applications for Flexi. Rockwool Limited does not accept responsibility for the consequences of using Flexi in applications different from those described above. Expert advice should be sought where such different applications are contemplated, or where the extent of any listed application is in doubt.

**ROCKWOOL**

Rockwool Limited  
Pencoed, Bridgend. CF35 6NY

E [info@rockwool.co.uk](mailto:info@rockwool.co.uk)  
[www.rockwool.co.uk](http://www.rockwool.co.uk)